

KIT/301-08LB-P8/8*2122LR3-PF40M-D



Key Features

NVR301-08LB-P8

- Support Ultra 265/H.265/H.264 video formats
- 8-channel input
- Plug & Play with 8 independent PoE network interfaces
- Third-party IP cameras supported with ONVIF conformance: Profile S, Profile G, Profile T
- Support 1-ch HDMI, 1-ch VGA
- HDMI and VGA simultaneous output
- Up to 2MP resolution recording
- 1 SATA HDD, up to 8 TB
- Support cloud upgrade

IPC2122LR3-PF40M-D

- Day/night functionality
- Smart IR ,up to 30 m (98 ft) IR distance
- Optical glass window with higher light transmittance
- IR anti-reflection window to increase the infrared transmittance

- 2D/3D DNR (Digital Noise Reduction)
- Triple streams
- IP67

Specifications

Model	NVR301-08LB-P8
Video/Audio Input	
IP Video Input	8-ch
Network	
Incoming Bandwidth	40Mbps
Outgoing Bandwidth	40Mbps
Remote Users	128
Protocols	P2P, UPnP, NTP, DHCP, PPPoE
Video/Audio Output	
HDMI/VGA Output	HDMI: 1920x1080p /60Hz, 1920x1080p /50Hz, 1600x1200 /60Hz, 1280x1024 /60Hz, 1280x720 /60Hz, 1024x768 /60Hz VGA: 1920x1080p /60Hz, 1920x1080p /50Hz, 1600x1200 /60Hz, 1280x1024 /60Hz, 1280x720 /60Hz, 1024x768 /60Hz
Recording Resolution	1080p/960p/720p/D1/2CIF/CIF
Synchronous Playback	8-ch
Corridor Mode Screen	3/4/5/7/9
Decoding	
Decoding format	Ultra 265/H.265/H.264
Liveview/ Playback	1080p/960p/720p/D1/2CIF/CIF
Capability	2 x 1080p@30, 4 x 720p@30
Hard Disk	
SATA	1 SATA interface
Capacity	up to 8TB for each disk
External Interface	
Network Interface	1 RJ45 10M/100M self-adaptive Ethernet Interface
USB Interface	Rear panel: 2 x USB2.0
PoE	
Interface	8 independent 100 Mbps PoE network interfaces
Max Power	Max 30W for single port Max 108W in total (13.5W for each)
Supported Standard	IEEE 802.3at, IEEE 802.3af
General	
Power Supply	52V DC Power Consumption: ≤9 W(without HDD)
Working Environment	-10°C ~ + 55°C (+14°F ~ +131°F), Humidity ≤ 90% RH(non-condensing)

Dimensions(W×D×H)	270mm × 205mm × 42mm(10.6"×8.1"×1.7")
Weight (without HDD)	0.98kg (2.16lb)
Model	IPC2122LR3-PF40M-D
Camera	
Sensor	1/2.7", 2.0 megapixel, progressive scan, CMOS
Lens	4.0mm@F1.8
Angle of View(H)	86.5°
Shutter	Auto/Manual, 1/6~1/100000 s
Minimum Illumination	Colour: 0.02 Lux (F1.8, AGC ON) 0 Lux with IR on
Digital noise reduction	2D/3D DNR
Day/Night	IR-cut filter with auto switch (ICR)
S/N	>52dB
IR Range	Up to 30m (98 ft) IR range
WDR	DWDR
Video	
Video Compression	Ultra 265,H.265, H.264, MJPEG
H.264 code profile	Baseline profile, Main Profile, High Profile
Frame Rate	Main Stream:2MP (1920×1080): Max. 30 fps; Sub Stream:720P (1280×720): Max. 30 fps; Third Stream: 4CIF (704×576): Max.30 fps
HLC	Supported
BLC	Supported
OSD	Up to 4 OSDs
Privacy Mask	Up to 8 areas
ROI	Up to 2areas
Motion Detection	Up to 4 areas
Network	
Protocols	IPv4, IGMP, ICMP, ARP, TCP, UDP, DHCP, RTP, RTSP, RTCP, DNS, DDNS, NTP, FTP, UPnP, HTTP, HTTPS, SMTP
Compatible Integration	ONVIF(Profile S), API

Interface	
Network	1 RJ45 10M/100M Base-TX Ethernet
General	
Power	12 V DC±25%, PoE (IEEE802.3 af)
	Power consumption: Max 5.5W
Dimensions (L × W × H)	162.9 × 62.4 × 62.7 mm (6.4" × 2.5" × 2.5")
Weight	0.34kg (0.75 lb)
Working Environment	-30°C ~ +60°C (-22°F ~ 140°F), Humidity :10%~95% RH(non-condensing)
Ingress Protection	IP67
Reset Button	Supported
Carton	NVR301-08LB-P8*1/ IPC2122LR3-PF40M-D*8
Dimensions(W×D×H)	340mm × 232mm × 571mm (13.4"× 9.13" × 14.21")
Weight	3.4kg (7.50lb)

Dimensions

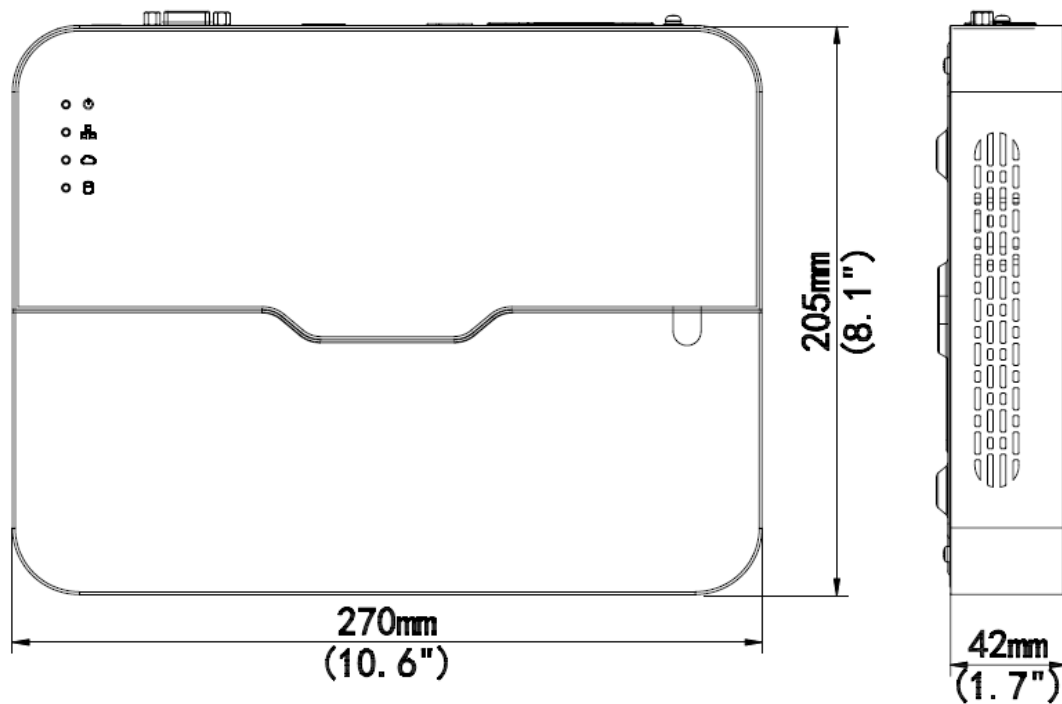

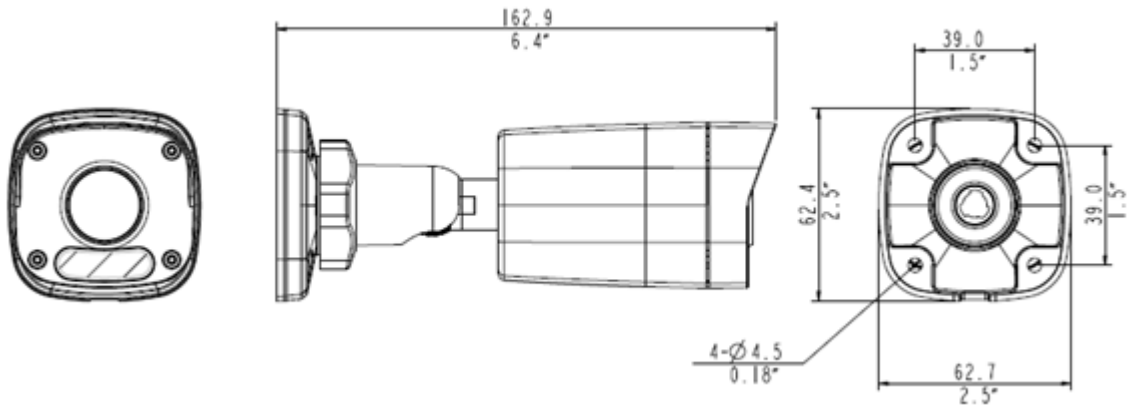

Rear Panel

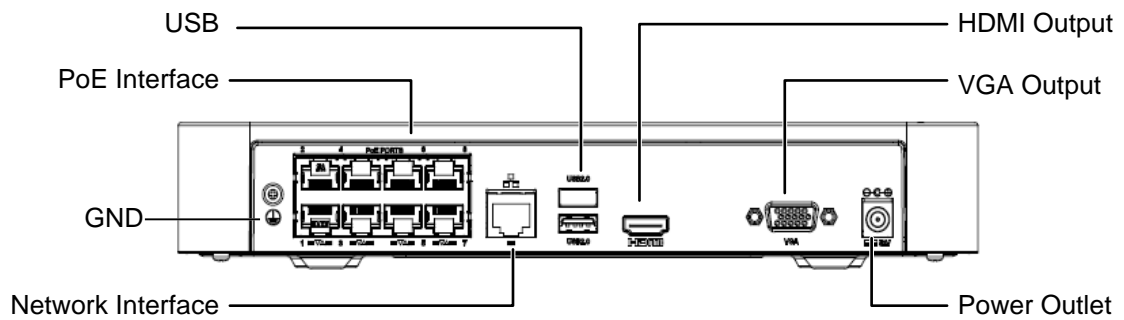

Zhejiang Uniview Technologies Co.,Ltd.

Building No.10, Wanlun Science Park, Jiangling Road 88, Binjiang District, Hangzhou, Zhejiang, China

Email: overseasbusiness@uniview.com; globalsupport@uniview.com

<http://www.uniview.com>

©2018 Zhejiang Uniview Technologies Co.,Ltd. All rights reserved.

*Product specifications and availability are subject to change without notice.